

# PHANTOM 4

## Quick Start Guide

V1.2

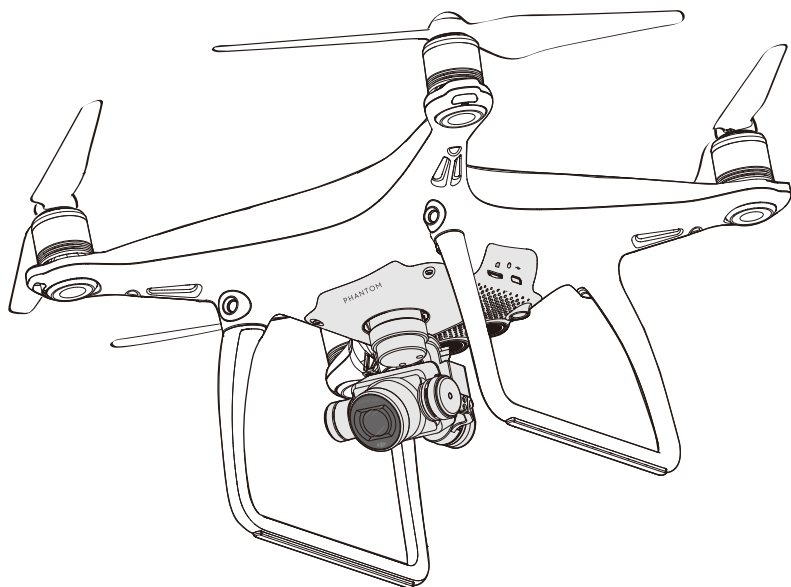

# Phantom 4

The DJI Phantom 4 is an extremely smart flying camera able to intelligently track subjects without a separate device, avoid obstacles and fly with a tap of your finger. All while shooting 4K video or 12 megapixel stills.

TapFly and ActiveTrack are two brand new commands in the DJI GO app, unique to the Phantom 4. Now with a simple tap you can fly anywhere visible on your screen or track a moving subject smoothly and easily.

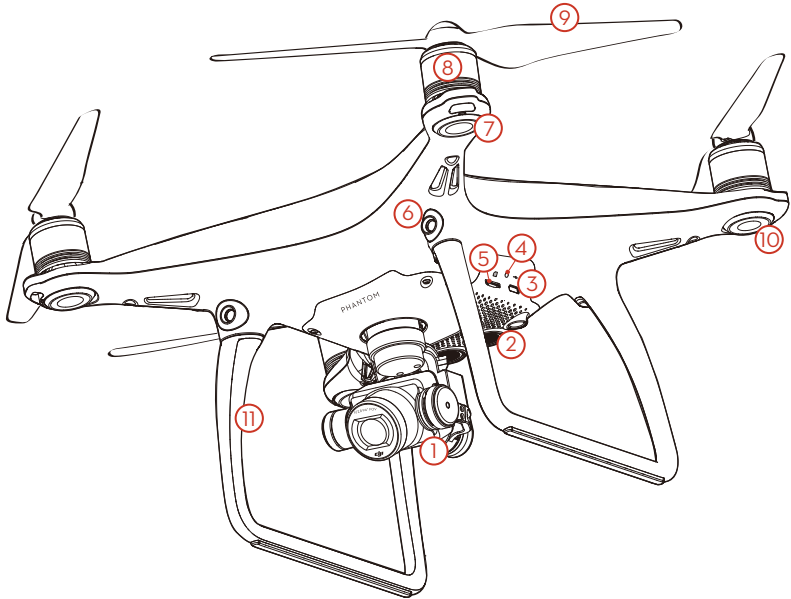

- |  |                                |
|--|--------------------------------|
| 1. Gimbal and Camera                               | 8. Motors                      |
| 2. Vision Positioning System                       | 9. Propellers                  |
| 3. Micro USB Port                                  | 10. Aircraft Status Indicators |
| 4. Camera/Linking Status Indicator and Link Button | 11. Antennas                   |
| 5. Camera Micro SD Card Slot                       | 12. Intelligent Flight Battery |
| 6. Obstacle Sensing System*                        | 13. Power Button               |
| 7. Front LEDs                                      | 14. Battery Level Indicators   |

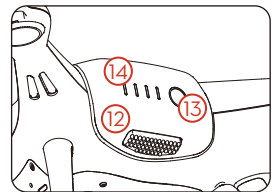

\* The Obstacle Sensing System is affected by surrounding conditions. Read the Disclaimer and Safety Guidelines and watch the tutorials in the DJI GO app or on the official DJI website to learn more.

# Remote Controller

This powerful remote controller allows you to operate your Phantom 4 up to 3.1 mi (5 km)\*, while giving you buttons and dials for exposure, camera tilt, photo capture and video recording.

Built into the remote controller is DJI Lightbridge, which when paired with a compatible mobile device gives you a live HD view from the Phantom's camera. An internal battery ensures a long battery life and ease of use.

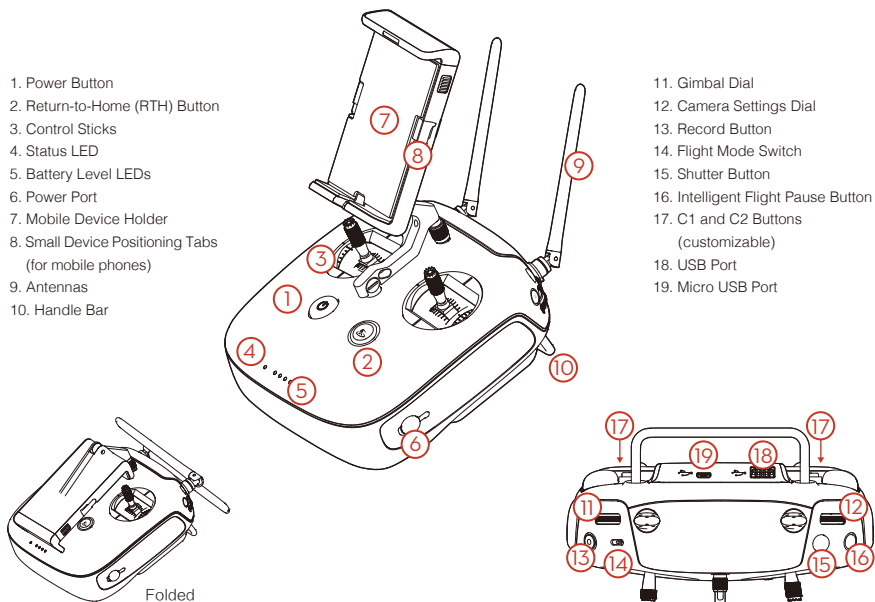

The default flight control is known as Mode 2. The left stick controls the aircraft's altitude and heading, while the right stick controls its forward, backward, left and right movements. The gimbal dial controls the camera's tilt.

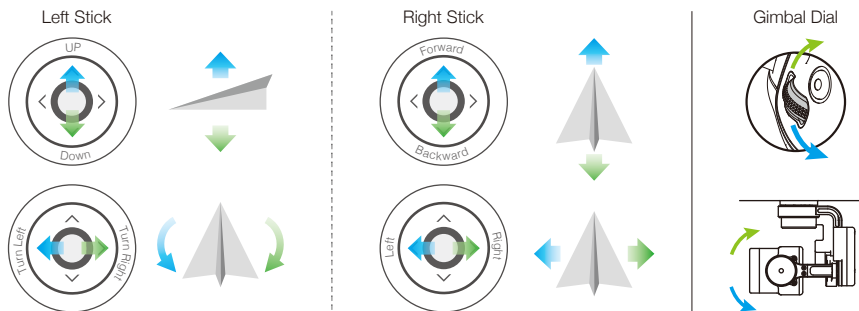

\* The remote controller is able to reach its maximum transmission distance in a wide open area with no magnetic interference, and at an altitude of about 400 feet (120 meters).

# Using PHANTOM 4

## 1. Download the DJI GO App

Search for 'DJI GO' on the App Store or Google Play, and install the app on your mobile device.



DJI GO App

## 2. Watch the Tutorial Videos

Watch the tutorial videos at [www.dji.com](http://www.dji.com) or in the DJI GO app.



Tutorial Videos

 • DJI GO supports iOS 8.0 (or later) or Android 4.1.2 (or later).

## 3. Check the Battery Levels

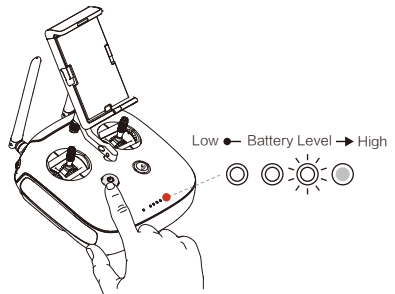
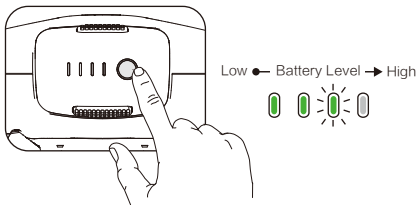

Press once to check the battery level. Press once, then again and hold to turn on/off.

## 4. Charge the Batteries

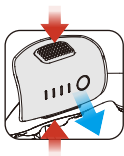

Remove the battery.

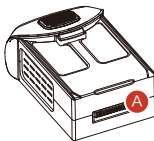

Charge Time:  
~1 hr 20 min

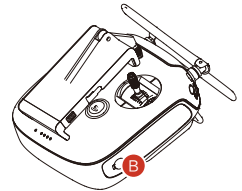
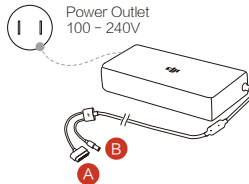

Charge Time:  
~3 hr 40 min

 • When charging is complete, the battery level indicators will automatically turn off.



## 5. Prepare the Remote Controller

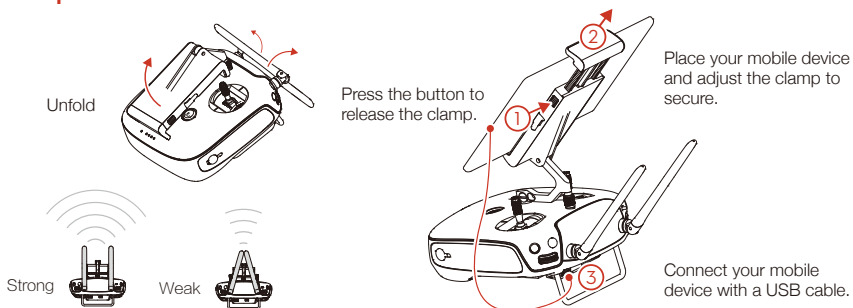

## 6. Prepare for Takeoff

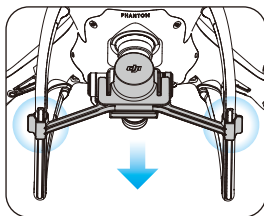

Remove the gimbal clamp from the camera.

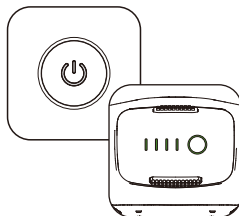

Power on the remote controller and the aircraft.



Launch DJI GO, complete the first-time setup, and enter Camera View.



First-time activation requires your DJI account and internet connection.



Tap the Aircraft Status Bar (top center). Choose 'Calibrate' and follow the instructions to calibrate the compass.

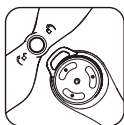

Black propeller rings go on motors with black dots.



Press the propeller down onto the mounting plate and rotate in the lock direction until secure.

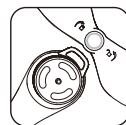

Silver propeller rings go on motors without black dots.

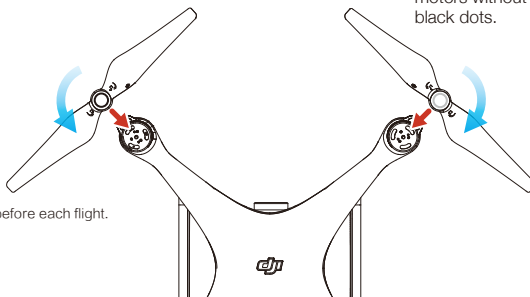

Check that the propellers are secure before each flight.

## 7. Flight

### Safe to Fly (GPS)

Before taking off, make sure the Aircraft Status Bar in the DJI GO app indicates 'Safe to Fly (GPS)' or 'Safe to fly (non-GPS)' if flying indoors.

In the DJI GO App:



#### Auto Takeoff

The aircraft will take off and hover at an altitude of 4 feet (1.2 meters).



#### Auto Landing

The aircraft will land vertically and stop its motors.



#### Return-to-Home (RTH)

Bring the aircraft back to the Home Point. Tap again to stop the procedure.



#### TapFly

Tap on your screen to fly your Phantom in that direction, avoiding obstacles as it flies.



#### ActiveTrack

Mark an object on your screen to track it as it moves.



#### Normal

You are in control of the Phantom, with satellite and Return-to-Home support.



#### Smart

Tap to use Point of Interest (POI), Waypoints and more.



- Watch the tutorial in the DJI GO app or on the official DJI website to learn more.
- Always set an appropriate RTH altitude before takeoff. When the aircraft is returning to the Home Point, you should guide it with the control sticks. Refer to the Disclaimer and Safety Guidelines for more details.

### Manual Takeoff

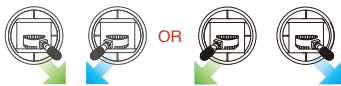

Combination Stick Command to start/stop the motors

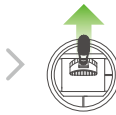

Left stick up (slowly) to take off

### Manual Landing



Left stick down (slowly) until you touch the ground  
Hold a few seconds to stop the motors



- Rotating propellers can be dangerous. Do not start the motors when there are people nearby.
- Always keep your hands on the remote controller so long as the motor is still spinning.
- **Stop motor mid-flight:** Pull the left stick to the bottom inside corner while simultaneously pressing the RTH button. Only stop motors mid-flight in emergency situations when doing so can reduce the risk of damage or injury. Refer to the user manual for details.



It's important to understand basic flight guidelines, for the safety of both you and those around you. Don't forget to read the Disclaimer and Safety Guidelines.



No Fly Zones

More information at:  
<http://flysafe.dji.com/no-fly>

## Specifications

### • Aircraft

Weight (Including Battery)	1380 g
Max Ascent Speed	6 m/s ( Sport mode )
Max Descent Speed	4 m/s ( Sport mode )
Max Speed	20 m/s ( Sport mode )
Max Service Ceiling Above Sea Level	19685 feet ( 6000 m ) ( Software altitude limit: 400 feet above takeoff point )
Max Flight Time	Approx. 28 minutes
Operating Temperature Range	32° to 104° F ( 0° to 40° C )
Satellite Systems	GPS / GLONASS

### • Gimbal

Controllable Range	Pitch: -90° to +30°
--------------------	---------------------

### • Obstacle Sensing System

Obstacle Sensory Range	2 – 49 feet ( 0.7 – 15 m )
Operating Environment	Surface with clear pattern and adequate lighting ( lux > 15 )

### • Vision Positioning System

Velocity Range	≤10 m/s ( 2 m above ground )
Altitude Range	0 – 33 feet ( 0 – 10 m )
Operating Range	0 – 33 feet ( 0 – 10 m )
Operating Environment	Surfaces with a clear pattern and adequate lighting ( lux > 15 )

### • Camera

Sensor	1/2.3" Effective pixels: 12 M
Lens	FOV ( Field Of View ) 94° 20 mm ( 35 mm format equivalent ) f/2.8 focus at ∞
ISO Range	100 – 3200 ( video ) 100 – 1600 ( photo )
Electronic Shutter Speed	8 s to 1/8000 s
Max Image Size	4000×3000
Still Photography Modes	Single shot

	Burst shooting: 3 / 5 / 7 frames
	Auto Exposure Bracketing ( AEB ) : 3 / 5 bracketed frames at 0.7 EV Bias
	Time-lapse, HDR
Video Recording Modes	UHD: 4096×2160 (4K) 24 / 25p 3840×2160 (4K) 24 / 25 / 30p 2704×1520 (2.7K) 24 / 25 / 30p
	FHD: 1920×1080 24 / 25 / 30 / 48 / 50 / 60 / 120p
	HD: 1280×720 24 / 25 / 30 / 48 / 50 / 60p

Max Video Bitrate	60 Mbps
Supported File Systems	FAT32 ( ≤ 32 GB ); exFAT ( > 32 GB )
Photo	JPEG, DNG ( RAW )
Video	MP4 / MOV ( MPEG – 4 AVC / H.264 )
Supported SD Cards	Micro SD, Max capacity: 64GB, Class 10 or UHS-1 rating required
Operating Temperature	32° to 104° F ( 0° to 40° C )

### • Remote Controller

Operating Frequency	2.400 GHz to 2.483 GHz
Max Transmission Distance	FCC Compliant: 3.1 mi ( 5 km ) ; CE Compliant: 2.2 mi ( 3.5 km ) ( Unobstructed, free of interference )
Operating Temperature	32° to 104° F ( 0° to 40° C )
Battery	6000 mAh LiPo 2S
Transmitter Power ( EIRP )	FCC: 23 dBm; CE: 17 dBm
Operating Voltage	7.4V @ 1.2A

### • Charger

Voltage	17.4 V
Rated Power	100 W

### • Intelligent Flight Battery ( PH4 - 5350 mAh -15.2 V )

Capacity	5350 mAh
Voltage	15.2 V
Battery Type	LiPo 4S
Energy	81.3 Wh
Net Weight	462 g
Operating Temperature	14° to 104° F ( -10° to 40° C )
Max Charging Power	100 W

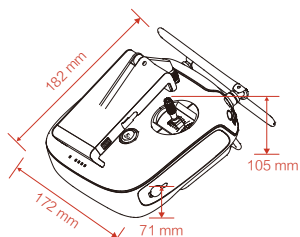
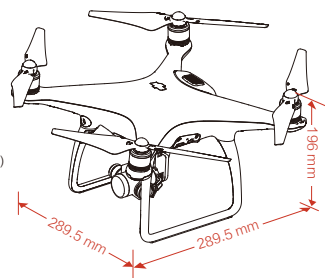

CE 1313

This device complies with part 15 of the FCC Rules. Operation is subject to the following two conditions:  
(1) This device may not cause harmful interference, and  
(2) this device must accept any interference received, including interference that may cause undesired operation.

Download the user manual for more information:

<http://www.dji.com/product/phantom-4>



※ This Quick Start Guide is subject to change without prior notice.

©2016 DJI. All Rights Reserved.  
Designed by DJI. Printed in China.

# PHANTOM 4